

# TECHNICAL DATA SHEET



Document No: TDS.G1040-13

Revision No: 00

## G1040 Corner Bead

■ Product Range	Plaster Profiles
■ Applications	Interior Plaster
■ Product Type	6 Mesh Corner Bead
■ Plaster Thickness	12 mm
■ Material	Galvanized Sheet Steel DX51D+Z to EN 10142
■ Coating /Finish /Colour	100 g/m <sup>2</sup> Zinc Coating
■ Material Thickness	0,40 mm
■ Wings /Length	46x46 mm
■ Standards	EN 13658-1
■ Reaction to Fire	Class A1
■ DOP Reference	DOP.G1040
■ Length Options	250, 260, 270, 280, 300 cm
■ Art Nr.	G10401300 G10401301
■ Packaging	25 pcs/bun 50 pcs/cts

### Remarks:

This technical data sheet replaces all previous versions. Işık reserves the right to modify products without prior notice. Please rely on the application assembly and storage guidelines.

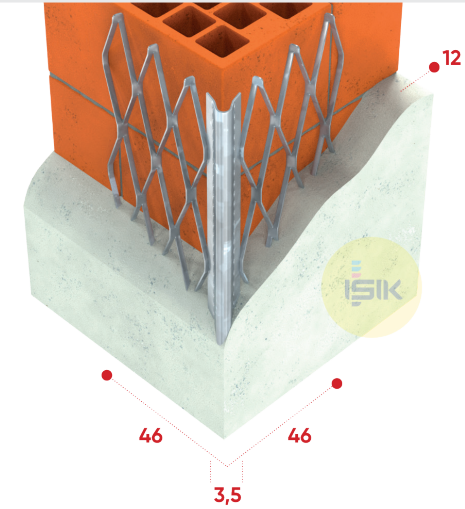
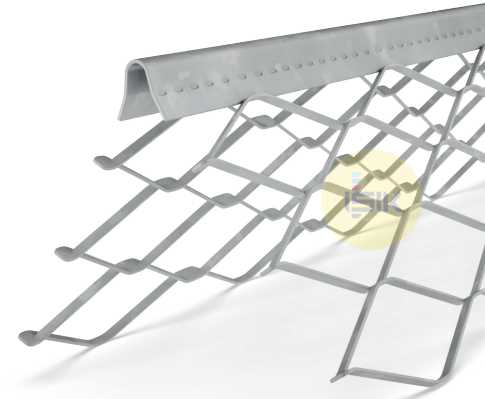

### MANUFACTURER:

Gebze Plastikçiler OSB, Atatürk Bulvarı 11.  
Cad. No:9 Gebze 41400, Kocaeli - Türkiye  
T: +90 262 502 16 60  
isikgroup.com