

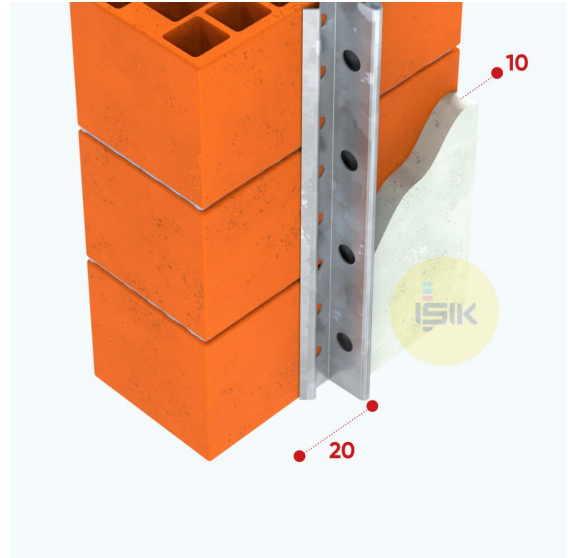

A1410 Depth Gauge Bead

Product Range	Plaster Profiles
Applications	Interior Plaster
Product Type	Depth Gauge Bead Perforated
Plaster Thickness	10 mm
Material	Aluminium Natural
Material Thickness	0,40 mm
Wings / Width	20 mm
Reaction to Fire	Class A1
Length Options	220, 250, 260, 270, 275, 280, 300 cm

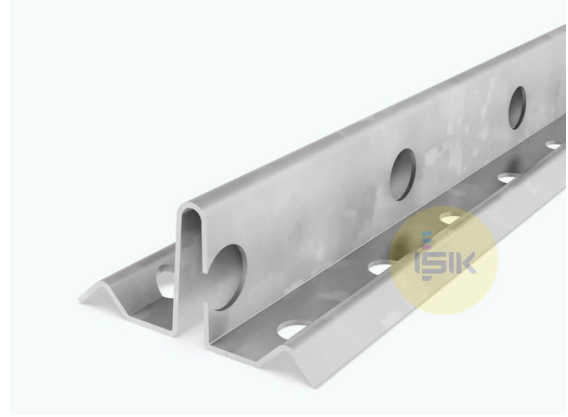

Art Nr.	Packaging
A14109301	100 pcs/ cts



Remarks:

This technical data sheet replaces all previous versions. IŞIK reserves the right to modify products without prior notice. please rely on the application assembly and storage guidelines.